



ROOFING



Introduction



The lifetime of a building begins with the choice of materials and for hundreds of years, architects and designers have been inspired by the natural beauty of slate. Through its aesthetic potential and practical qualities this material's unique character enhances the architectural vision.

Welsh//Slate roofing is extracted from some of the world's finest deposits. Formed up to 590 million years ago, each piece of slate has its own unique fingerprint that reflects the power and presence of the landscapes from which it was hewn.

Direct from the source

Welsh//Slate Ltd own and operate the famous Penrhyn and Cwt-y-Bugail quarries in North Wales.

Longevity and value

The quality of Welsh slate roofing is such that even after 100 years of use at least 50% of Welsh slate is typically re-used. There are buildings around the world which have Welsh slate roofing tiles which are several hundred years old. There is no other roofing material which has demonstrated this extraordinary durability. The result of this longevity is that Welsh slate is a very cost effective roofing material as it is less costly to maintain and has a lower frequency of re-roofing. In addition a second hand Welsh slate has a typical value of 60% of a new slate.

Welsh slate roofing offers:-

- A beautiful natural appearance
- Non fading colours
- Most durable roofing slate in the world
- UK manufacture
- 100 year plus useful life

In addition to roofing slate, Welsh//Slate also manufacture flooring, paving, cladding, walling, worktops and landscaping products.



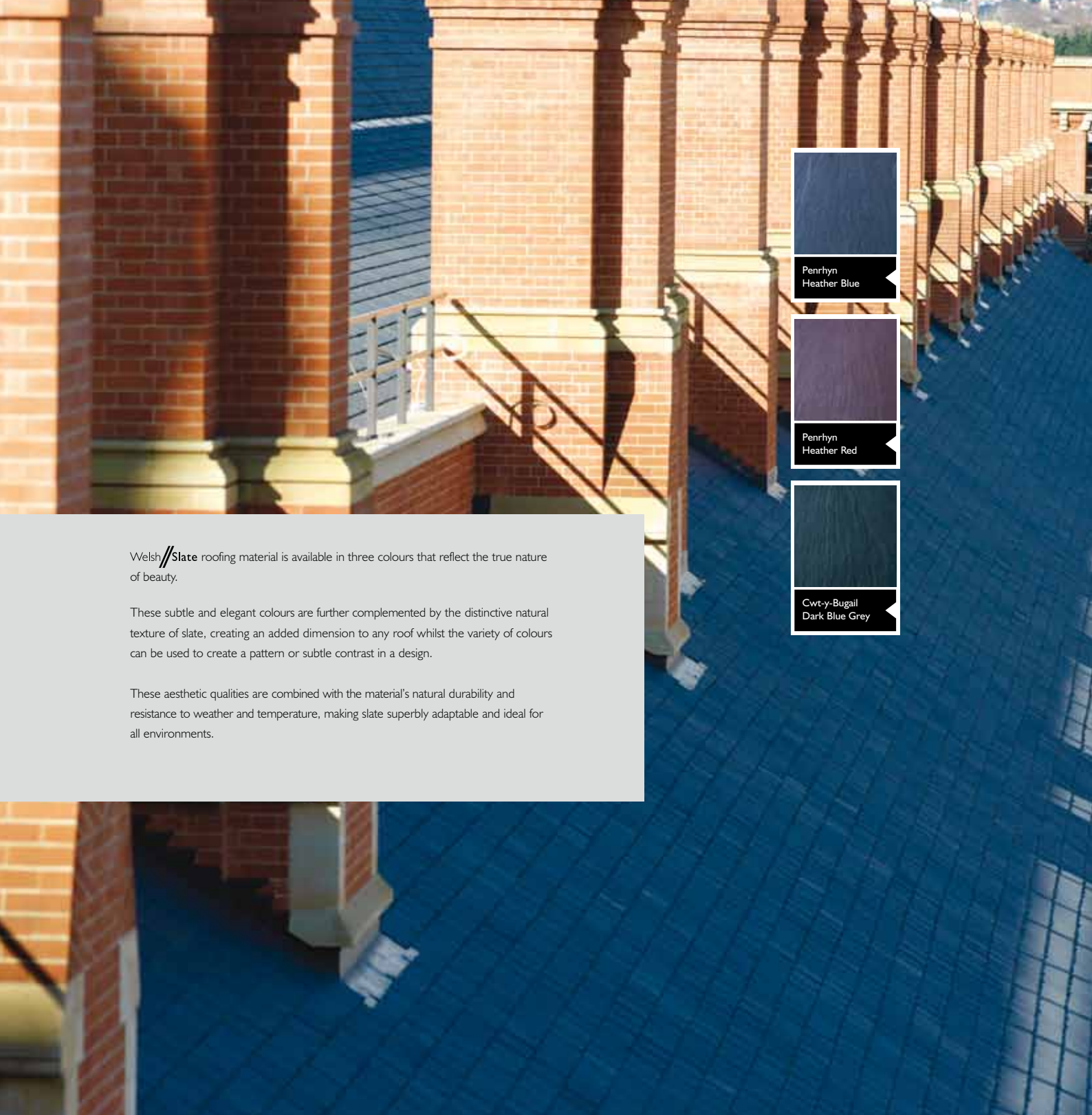

Penrhyn
Heather Blue



Penrhyn
Heather Red



Cwt-y-Bugail
Dark Blue Grey

Welsh//Slate roofing material is available in three colours that reflect the true nature of beauty.

These subtle and elegant colours are further complemented by the distinctive natural texture of slate, creating an added dimension to any roof whilst the variety of colours can be used to create a pattern or subtle contrast in a design.

These aesthetic qualities are combined with the material's natural durability and resistance to weather and temperature, making slate superbly adaptable and ideal for all environments.

As Welsh//Slate produces only natural products from the finest raw material each slate has its own unique visual characteristics. Heather Blue and Heather Red slate often feature naturally occurring markings which are usually green.

The quality of Welsh//Slate allows roofing slate to be produced to 48" (1.2m) or larger.

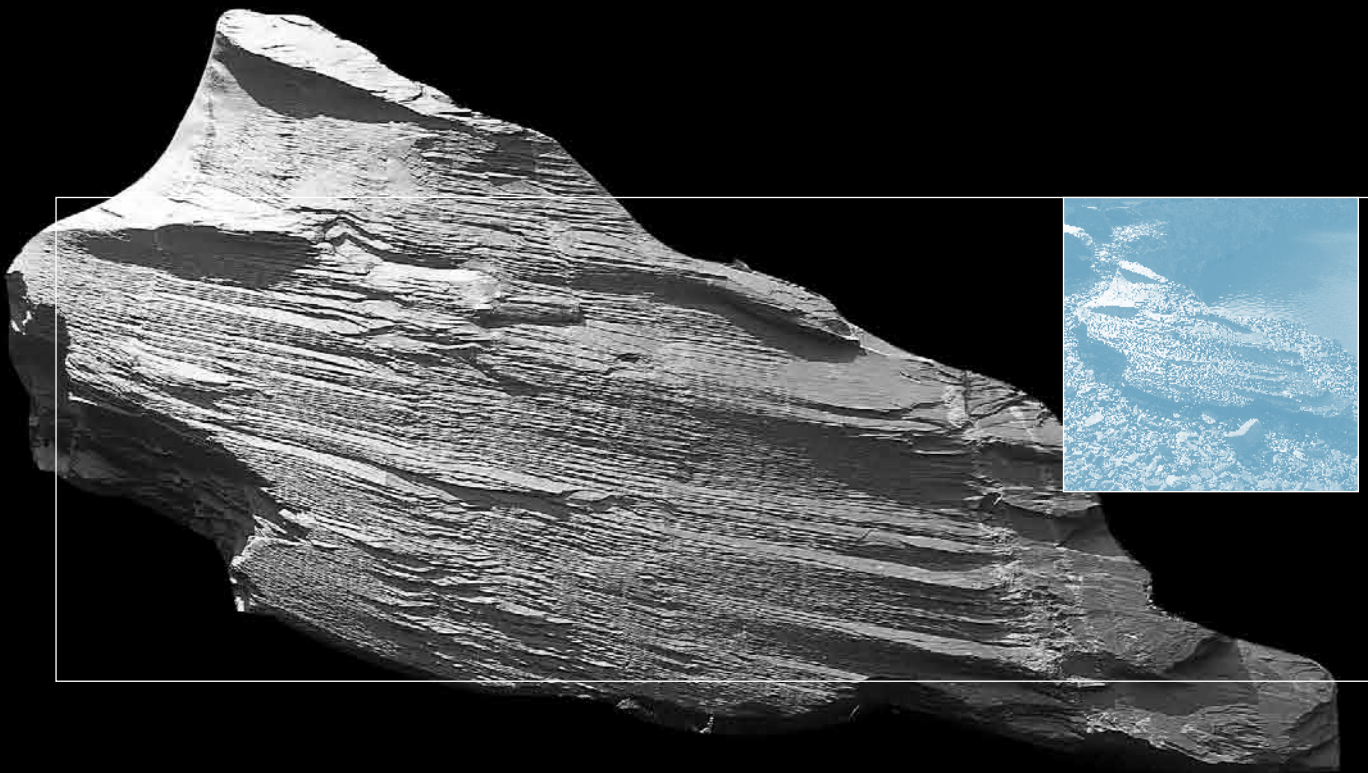

Advantages of Slate

3 <

Practical

Welsh slate is exceptionally durable. It is unaffected by normal extremes of temperature and is highly resistant to acids, alkalis and other chemicals. It retains its colour, even in UV light and is impermeable to water. Welsh slate is non-combustible and is compatible with all other building materials.

Aesthetic

Welsh slate combines beautifully with traditional and modern materials and provides the designer with a choice of colours and a natural, distinctive, texture. A Welsh slate roof adds character and quality to any building.

Proven Longevity

Welsh slate has hundreds of years of history and has proven to be the highest quality roofing material in the world. Welsh slate can provide numerous case studies and 100 year guarantees are available.

Cost Effective

The typical additional cost of a Welsh slate roof compared with an imported slate is 9%. In return for this minimal difference customers receive a beautiful, distinctive, roofing material that is less costly to maintain and is likely to last significantly longer than the cheaper alternatives.

Environmentally Responsible

Unlike many other roofing products, Welsh slate is entirely produced in the UK. Our roofing slate is 100% natural and has a low carbon footprint to the UK market. In addition all Welsh//Slate products are produced to the exacting standards of ISO 14001 Environmental Management System. (see page 30 for more details)

LIFE EXPECTANCY COST COMPARISON FOR FIVE ROOFING PRODUCTS

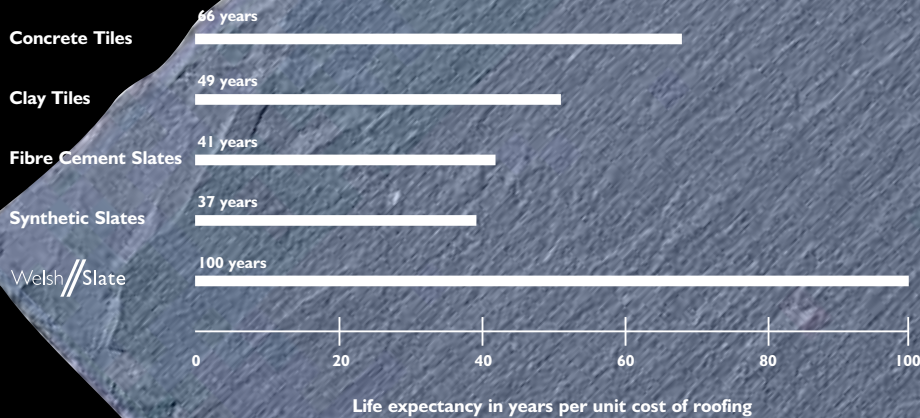

Roofing Product	Weight Kg/m ²	Durability Years	Repairs & Maintenance % of initial cost	Re-Roofing Frequency Times	Total Cost per unit £ per unit area
Concrete Tiles	51.0	30	10%	3.33	£152.59
Clay Tiles	63.0	40	10%	2.50	£202.86
Fibre Cement Slates	21.4	30	12%	3.33	£241.43
Synthetic Slates	24.7	30	12%	3.33	£268.34
Welsh Slate	32.0	100	12%	1.00	£100.00

Comparison information from Building Magazine compiled by Mr Francois Moal (Managing Director of Eurocom Enterprise Ltd) February 1995.

Costs updated from AJ Focus compiled by Davis Langdon and Everest, July 1995.

All figures given are for roofing products throughout a 100 year life cycle.



TECHNICAL SUPPORT AND ADVICE

Welsh//Slate is dedicated to satisfying the needs of its customers through the provision of quality services and products combined with comprehensive after sales support.

Detailed technical advice is freely available from the company's highly trained and experienced Technical Department with an unrivalled knowledge of natural roofing slates. This includes assistance with Roof Specification and Cost Estimation via a computer-based system.

Welsh//Slate can also provide a list of approved roofing contractors for the UK and Ireland.

Customer Services



References

The following References and Standards should be referred to when specifying or fixing natural slate roofing products.

BS EN 12326-1:2004

Specification for slate and stone products for discontinuous roofing and cladding.

BS 747:2000

Specification for roofing felts.

BS 4016:1997

Specification for flexible building membranes (breather type).

BS 5534:2003

Code of practice for slating and tiling.

BS 8000

Workmanship on building sites:
Part 6:1990, Code of practice for slating and tiling of roofs and claddings.

BS 1202:1974

Specification for nails.

BS 6399

Part 2:1997, Code of practice for wind loads.

Part 3:1988, Code of practice for imposed roof loads.

BS 5250:2002

Code of practice for control of condensation in buildings.

BS 8104:1992

Code of practice for assessing exposure to wind-driven rain.

Design Specifications

- 8 Terminology
- 9 Driving Rain Index
- 10 Minimum Recommended Headlaps
- 11 General Properties
- 12 Slate sizes and weights
- 13 Coverage
- 14 Battening and Holing Gauges

Technical Details

- 15 The Slating Process
- 16 Scottish Roofing Practice
- 17 Battening
- 19 Eaves and Verges
- 20 Valleys
- 21 Hips
- 22 Hips
- 23 Abutments
- 24 Ridges
- 25 Changes in Roof Pitch
- 26 Vertical Slating
- 27 Roof Ventilation
- 28 Roof Ventilation



Design Specification

7

General guidance on design is given here but for further details, please refer to BS 5534: 2003 Code of Practice for Slating and Tiling.

We recommend that early contact is made with our Technical Department who can carry out detailed comparative costings on request. They will also advise on roof design and provide information on Approved Roofing Contractors to ensure the natural roofing slates are fixed in accordance with BS 5534 and BS 8000.

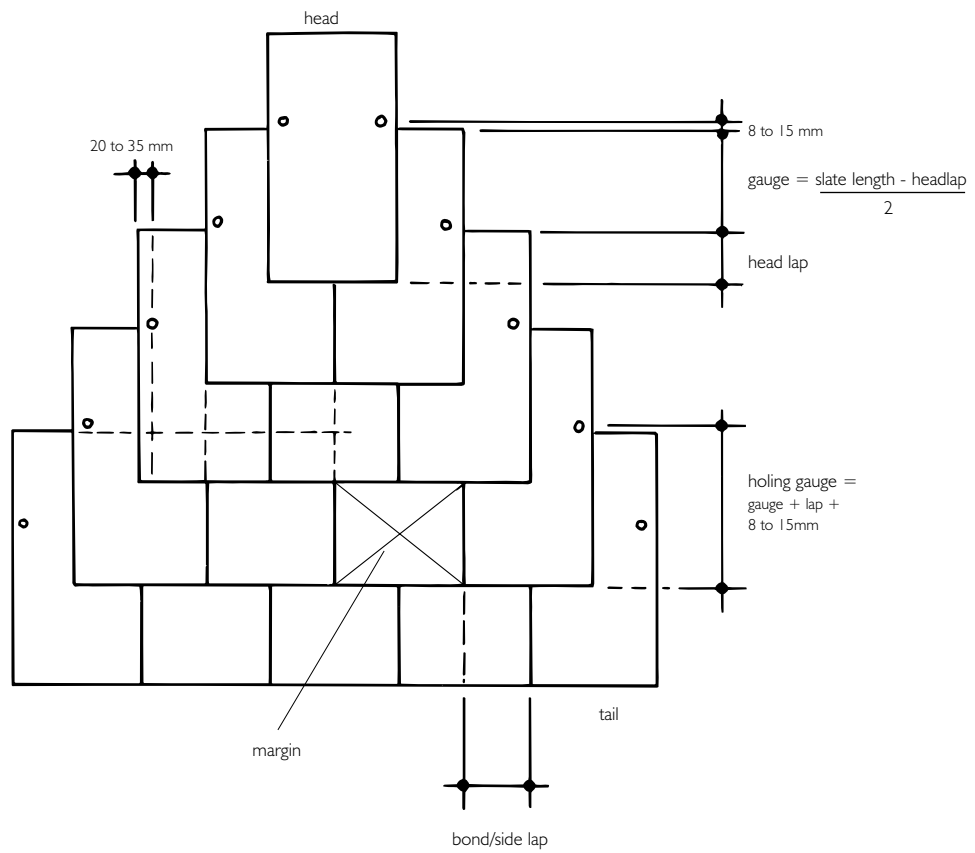

Terminology

The above diagram gives a brief explanation of the terms that are commonly used throughout the roofing industry. They are by no means comprehensive and the terms may vary in different parts of the country. We suggest that further reference is made to BS 6100: Subsection 1.3.2: 1989 - Building and Civil Engineering Terms - Roofs and Roofing.

This map shows the annual driving rain index. Exposure gradings and local knowledge should be referred to when discussing design requirements.

Further information is available from the Welsh//Slate Technical Department.



Annual driving rain index

UNITED KINGDOM

In general, any area within 30 miles of a west facing coastline is considered to be in a severe exposure area.

However, localised effects on any site must also be taken into consideration.

Further reference to BS 8104 is advisable to ascertain localised effects.

Map based on BS 5534.

MODERATE EXPOSURE less than 56.5 l/m² per spell

Size (Nominal) mm	Minimum Rafter Pitch								
	20°	22.5°	25°	27.5°	30°	35°	40°	45° to 75°	85°
600 x 350	115	105	95	85	80	70	60	55	-
600 x 300	-	-	95	85	80	70	60	55	-
550 x 300	-	105	95	85	80	70	60	55	-
500 x 300	115	105	95	85	80	70	60	55	-
500 x 250	-	-	95	85	80	70	60	55	50
450 x 300	-	-	-	-	80	70	60	55	50
450 x 250	-	-	-	-	80	70	60	55	50
400 x 300	-	-	-	-	80	70	60	55	50
400 x 250	-	-	-	-	80	70	60	55	50
400 x 200	-	-	-	-	80	70	60	55	50
350 x 300	-	-	-	-	80	70	60	55	50
350 x 250	-	-	-	-	80	70	60	55	50
350 x 200	-	-	-	-	80	70	60	55	50
300 x 200	-	-	-	-	80	70	60	55	50
250 x 150	-	-	-	-	80	70	60	55	50

SEVERE EXPOSURE 56.5 l/m² or greater per spell

Size (Nominal) mm	Minimum Rafter Pitch								
	20°	22.5°	25°	27.5°	30°	35°	40°	45° to 75°	85°
600 x 350	-	130	120	110	100	90	80	70	-
600 x 300	-	-	-	-	100	90	80	70	-
550 x 300	-	130	120	110	100	90	80	70	-
500 x 300	-	130	120	110	100	90	80	70	-
500 x 250	-	-	-	110	100	90	80	70	65
450 x 300	-	-	-	-	100	90	80	70	65
450 x 250	-	-	-	-	100	90	80	70	65
400 x 300	-	-	-	-	100	90	80	70	65
400 x 250	-	-	-	-	100	90	80	70	65
400 x 200	-	-	-	-	100	90	80	70	65
350 x 300	-	-	-	-	100	90	80	70	65
350 x 250	-	-	-	-	100	90	80	70	65
350 x 200	-	-	-	-	100	90	80	70	65
300 x 200	-	-	-	-	100	90	80	70	65
250 x 150	-	-	-	-	100	90	80	70	65

(Based on BS 5534: 2003 - All headlaps have been rounded up to the nearest 5mm increment)

Minimum Recommended Headlaps

The recommendations for minimum pitches and laps for slate tiles apply to normal situations. In general, the recommendations apply to rafter lengths of not more than 9m in driving rain exposures of less than 56l/m² per spell and 6m in driving rain exposures greater than 56 l/m² per spell. Specifiers should take account of any abnormal conditions that might apply and may need to specify greater values than the recommended minima. If it is necessary to use pitches lower than the recommended minima, special precautions should be taken.

This table gives a range of sizes for your information.

Traditional sizes that are not listed above and random diminishing slates can be made to special order, please contact us for more information.

WIND LOADS AND WEATHER RESISTANCE

Slates fixed in accordance with the details given in this guide will have adequate resistance to wind loads, wind uplift and rain penetration under most conditions

The tables above give minimum recommended laps according to exposure, roof pitch and slate size. Detailed guidance on wind load calculations is given in BS 5534: 2003 and BS 6399, Part 2:1997 and Part 3:1998

General Properties

Slate benefits from a number of highly practical properties.

It is exceptionally durable, unaffected by normal extremes of temperature and is highly resistant to acids, alkalis and other chemicals it is an ideal roofing material.

In addition, slate is non-combustible, retains its colour, even in UV light and is impermeable to water.

Water permeability	Impermeable
Sunlight unfading	Unaffected by UV light
Heat	Unaffected by normal heating, freezing and thermal cycling
Chemical resistance	Unaffected by atmospheric pollution, sea air and sea spray
Biological resistance	Unaffected by vegetable growth, rot or insect attack
Compatibility	Compatible with all building materials
Fire resistance	Slate is non combustible and does not support combustion. AA fire rating
Thermal expansion	8.5 - 11 x 10 ⁻⁶ mm per °C
Thermal conductivity	Approx. 2.0 W/mk

Conformity to ASTM

Requirements for S1 classification (expected use of 75 - 100 years)

C120	Breaking load > 2558N
C121	Water absorption < 0.25%
C217	Weather resistance < 0.05mm

All slates comply with S1 classification.

Conformity and testing to BS EN 12326 - 1:2004

All slates comply with S1 and T1 classification. Conformity also ensures that all slates are CE marked.

Certificates of compliance can be downloaded from our website www.welshslate.com

Welsh//Slate roofing has a life expectancy of over 100 years and is easily maintained, making it an economical and environmentally responsible choice.



Slate Sizes and Weights

Thicknesses shown are nominal

Please contact us for further information and details of availability on
Tel: 01248 600656

STANDARD SIZES & WEIGHTS IN TONNES PER 1000 SLATES

Size (Nominal) mm	Penrhyn Heather Blue		
	Capital	County	Celtic
	5.5mm	7mm	9mm
600 x 350	2.89	3.58	4.16
600 x 300	2.48	3.07	3.56
550 x 300	2.27	2.81	3.27
500 x 300	2.06	2.56	2.97
500 x 250	1.72	2.13	2.48
450 x 300	1.86	2.30	2.67
450 X 250	1.55	1.92	2.23
400 X 300	1.65	2.05	2.38
400 x 250	1.38	1.71	1.98
400 x 200	1.10	1.36	1.58
350 x 300	1.44	1.79	2.08
350 x 250	1.20	1.49	1.73
350 x 200	0.96	1.19	1.39
300 x 300	1.24	1.53	1.78
300 x 250	1.03	1.28	1.49
300 x 200	0.83	1.02	1.19

Slate thickness quoted are nominal and subject to variations as a natural product.

The weights shown are exclusive of any packaging, or crating material.
The weights for other thicknesses or sizes are available on request from our
Technical Department.

The above weights are approximate.

Other sizes may be available, please contact us for further information.

Coverage: Slates/m²

Size (Nominal)	Lap mm																
mm	50	55	65	70	75	80	85	90	95	100	105	110	115	120	125	130	150
600 x 350	10.2	10.3	10.5	10.6	10.7	10.8	10.9	11.0	11.2	11.3	11.4	11.5	11.6	11.7	11.9	12.0	12.5
600 x 300	11.9	12.0	12.3	12.4	12.5	12.6	12.7	12.9	13.0	13.1	13.2	13.4	13.5	13.7	13.8	14.0	14.6
550 x 300	13.1	13.2	13.5	13.7	13.8	14.0	14.1	14.3	14.4	14.6	14.7	14.9	15.1	15.2	15.4	15.6	16.4
500 x 300	14.6	14.7	15.1	15.2	15.4	15.6	15.8	16.0	16.2	16.4	16.6	16.8	17.0	17.3	17.5	17.7	18.7
500 x 250	17.4	17.6	18.0	18.2	18.5	18.7	18.9	19.1	19.4	19.6	19.9	20.1	20.4	20.6	20.9	21.2	22.4
450 x 300	16.4	16.6	17.0	17.3	17.5	17.7	18.0	18.2	18.5	18.7	19.0	19.3	19.6	19.9	20.2	20.5	21.9
450 x 250	19.6	19.9	20.4	20.6	20.9	21.2	21.5	21.8	22.1	22.4	22.7	23.1	23.4	23.8	24.1	24.5	26.1
400 x 300	18.7	19.0	19.6	19.9	20.2	20.5	20.8	21.2	21.5	21.9	22.2	22.6	23.0	23.4	23.8	24.3	
400 x 250	22.4	22.7	23.4	23.8	24.1	24.5	24.9	25.3	25.7	26.1	26.6	27.0	27.5	28.0	28.5	29.0	
400 x 200	27.9	28.3	29.1	29.6	30.0	30.5	31.0	31.5	32.0	32.5	33.1	33.6	34.2	34.8	35.5	36.1	
350 x 300	21.9	22.2	23.0	23.4	23.8	24.3	24.7	25.2	25.7	26.2	26.8	27.3	27.9				
350 x 250	26.1	26.6	27.5	28.0	28.5	29.0	29.6	30.2	30.8	31.4	32.0	32.7	33.4				
350 x 200	32.5	33.1	34.2	34.8	33.5	36.1	36.8	37.5	38.3	39.0	39.8	40.7	41.5				
300 x 300	26.2	26.8	27.9	28.5	29.1	29.8	30.5	31.2	32.0	32.8							
300 x 250	31.4	32.0	33.4	34.1	34.9	35.7	36.5	37.3	38.3	39.2							
300 x 200	39.0	39.8	41.5	42.4	43.4	44.3	45.4	46.5	47.6	48.8							

Values calculated using nominal sizes and incorporating a 5mm joint gap as per BS 8000: Part 6 : 1990. We recommend the addition of at least 5% wastage allowance.

This table gives a range of sizes for your information.
Other sizes may be available, please contact us for further information.

Coverage

COVERAGE AND COST

The actual cost of a roof per unit floor area of the building is determined by a number of factors, including roof pitch, slate size and head lap.

ROOF PITCH AND LAP

Project specific advice is available from the Welsh  Slate Technical Department.

	Battening gauge mm	m batten per m ²	Holing gauge mm	Battening gauge mm	m batten per m ²	Holing gauge mm	Battening gauge mm	m batten per m ²	Holing gauge mm	Battening gauge mm	m batten per m ²	Holing gauge mm
Headlap	50mm			55mm			65mm			70mm		
Slate length mm												
600	275	3.64	335	273	3.67	338	268	3.74	343	265	3.77	345
550	250	4.00	310	248	4.04	313	243	4.12	318	240	4.17	320
500	225	4.44	285	223	4.49	288	218	4.60	293	215	4.65	295
450	200	5.00	260	198	5.06	263	193	5.19	268	190	5.26	270
400	175	5.71	235	173	5.80	238	168	5.97	243	165	6.06	245
350	150	6.67	210	148	6.78	213	143	7.02	218	140	7.14	220
300	125	8.00	185	123	8.16	188	118	8.51	193	115	8.70	195
Headlap	80 mm			85 mm			90 mm			95 mm		
Slate length mm												
600	260	3.85	350	258	3.88	353	255	3.92	355	253	3.96	358
550	235	4.26	325	233	4.30	328	230	4.35	330	228	4.40	333
500	210	4.76	300	208	4.82	303	205	4.88	305	203	4.94	308
450	185	5.41	275	183	5.48	278	180	5.56	280	178	5.63	283
400	160	6.25	250	158	6.35	253	155	6.45	255	153	6.56	258
350	135	7.41	225	133	7.55	228	130	7.69	230	128	7.84	233
300	110	9.09	200	108	9.30	203	105	9.52	205	103	9.76	208
Headlap	100mm			105mm			110mm			115mm		
Slate length mm												
600	250	4.00	360	248	4.04	363	245	4.08	365	243	4.12	368
550	225	4.44	335	223	4.49	338	220	4.55	340	218	4.60	343
500	200	5.00	310	198	5.06	313	195	5.13	315	193	5.19	318
450	175	5.71	285	173	5.80	288	170	5.88	290	168	5.97	293
400	150	6.67	260	148	6.78	263	145	6.90	265	143	7.02	268
350	125	8.00	235	123	8.16	238	120	8.33	240	118	8.51	243
300	100	10.00	210									
Headlap	120mm			125mm			130mm			150mm		
Slate length mm												
600	240	4.17	370	238	4.21	373	235	4.26	375	225	4.44	385
550	215	4.65	345	213	4.71	348	210	4.76	350	200	5.00	360
500	190	5.26	320	188	5.33	323	185	5.41	325	175	5.71	335
450	165	6.06	295	163	6.15	298	160	6.25	300	150	6.67	310
400	140	7.14	270	138	7.27	273	135	7.41	275			

Battening and Holing Gauges

This table gives a range of sizes for your information.

Other sizes may be available, please contact us for further information.

SETTING OUT THE ROOF

For a detailed description of the process of roof slating, reference should be made to BS 5534: 2003 Code of Practice for Slating and Tiling.

However, the basic steps are set out below:

- 1.1 Sort and hole slates where required. Slates should be holed from the underside to the correct gauge measured from the tail of the slate using a threaded action slate holing machine. At the same time the slates should be sorted into groups of equal thickness where required.
- 1.2 Fix the underlay as specified.
- 1.3 Mark out the roof to the correct battening gauge. The gauge may be adjusted to divide the slope length into equal margins provided the specified lap is not reduced.
- 1.4 Batten the roof (see Battening Gauges table).
- 1.5 Check the actual width of slates and mark out perpend on battens at correct centres allowing 5mm joint gaps.

SLATING

- 1.6 Where required load out the slates on the roof so that the thickest slates are in the lowest courses and the thinnest near the ridge.
- 1.7 Fix undereaves courses bed up.
- 1.8 Fix the slates to perpendicular lines, cutting individual slates as necessary to fit hips and valleys. Each slate must be fixed with two nails.

SLATE NAILS

- 1.9 Slate or clout nails should be aluminium to BS 1202: Part 3, copper to BS 1202: Part 2, or silicon-bronze.

In corrosive or marine atmospheres copper nails are preferable and in severe conditions silicon-bronze nails should be used.

CUTTING SLATES

- 1.10 In order to maintain adequate laps and allow proper fixing, slates must not be cut too narrow. In general no slates should be less than 150mm wide.

At all verges and abutments, alternate courses must be started either with half-width slates or with slate-and-a-half widths to maintain bond. If the half-slate would be less than 150mm, slate-and-a-half widths must be used.

At valleys, hips and other places where slates must be cut on the rake, it is essential that slates are of an adequate width to accommodate secure fixings.



The Slating Process

FIXING

Full details of the roof slating process are given in BS 5534. However, the main stages of the Traditional Scottish Practice are outlined below:

- 2.1 The roof should be covered with square edged sarking boards, covered with bitumen underlay or breather membrane, as specified by the architect. (Battens, although not generally specified, can be used to create a warm roof construction).
- 2.2 Sort and hole slates into at least three groups of equal thickness.
- 2.3 Hole the slates to the correct gauge, measuring from the tail of the slate.
- 2.4 Fix the underlay temporarily.
- 2.5 Mark out the roof to the correct gauge. This may be adjusted to divide the slope

length into equal numbers of courses. Care must be taken not to reduce the specified lap.

- 2.6 Load out the slates on the roof so that the thickest slates are in the lowest courses and the thinnest near the ridge.

- 2.7 Fix undereaves courses (bed side up).
- 2.8 Fix slates to perpend lines, cutting slates as necessary to fit hips and valleys.
- 2.9 Although BS 5534 recommends fixing with two nails, it is generally recognised that single head nailing is acceptable where slates are small and heavy. It is also recommended that a proportion of the slates (normally every third course) should be double nailed.
- 2.10 Slate or clout nails should be aluminium to BS 1202: Part 3, copper to BS 1202: Part 2, or silicon-bronze.

In corrosive or marine atmospheres copper nails are preferable, and in severe conditions silicon-bronze nails should be used. Slating nails should not penetrate through the board.

HOLING SLATES

- 2.11 Should slates need to be holed this must be done from the underside, using a threaded action slate holing machine. The resultant spalling on the upper surface forms a countersink for the head of the nail.

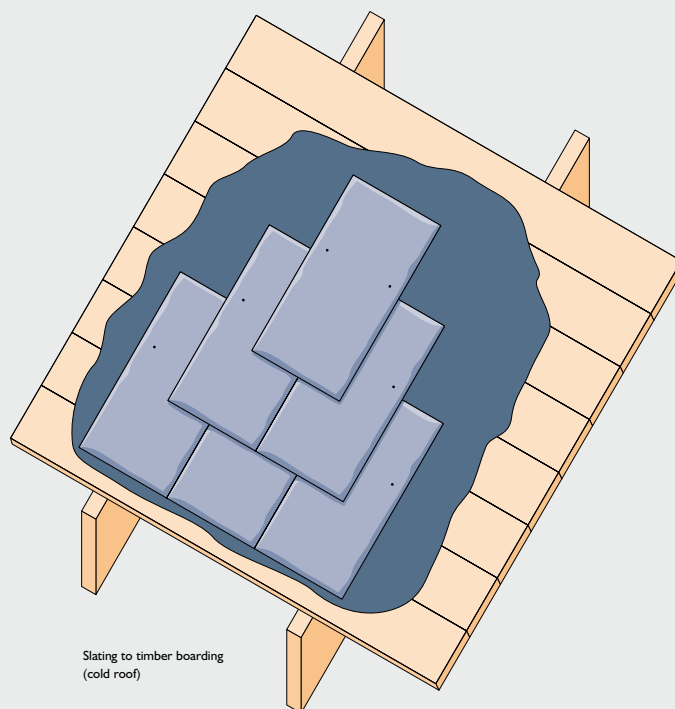

Traditional Scottish Roofing Practice

OPEN RAFTERS

Underlay should be reinforced bitumen felt type 1F to BS 747, or equivalent flexible pvc or polythene sheet.

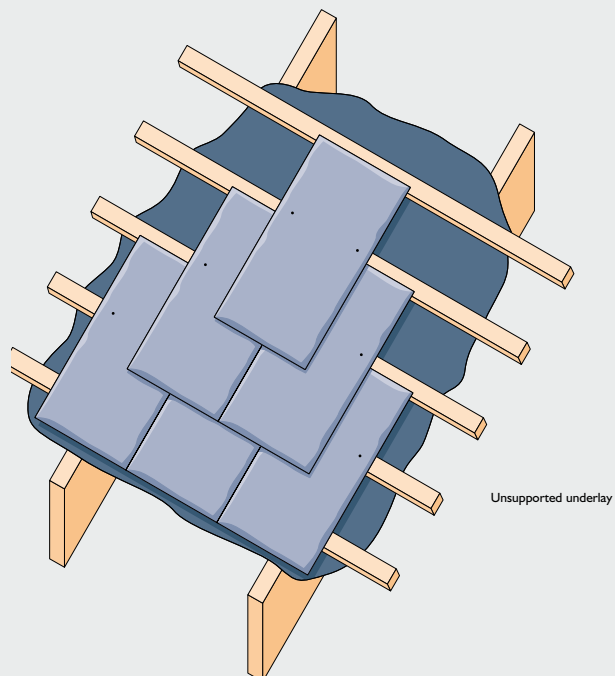

Unsupported underlay

BOARDED ROOFS

T&G or square edged boarding, woodwool slabs or bitumen-impregnated sarking board. Underlay laid directly onto boards should be of bitumen felt or vapour permeable meeting the requirements of BS 5534. Boarded roofs should be counter battened to allow ventilation under the slates and free drainage of any water that may reach the underlay.

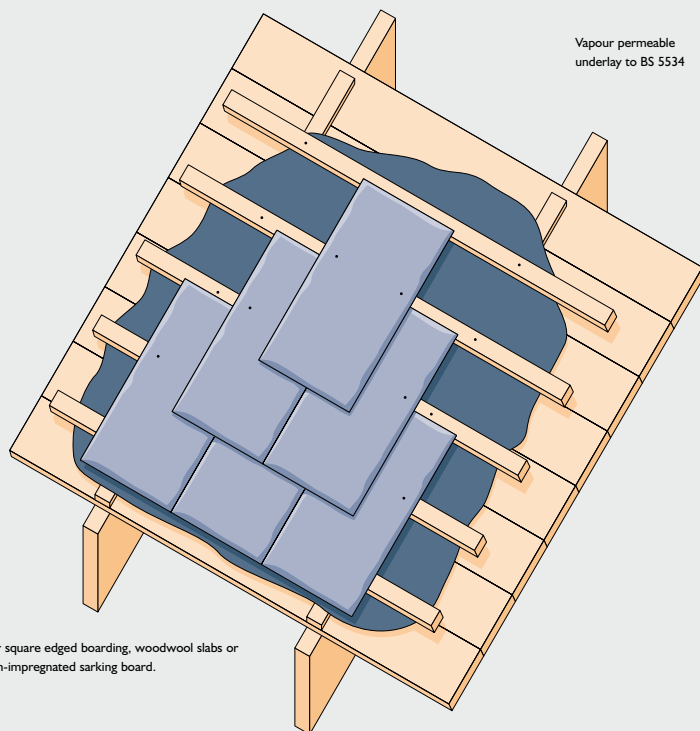

Vapour permeable underlay to BS 5534

T&G or square edged boarding, woodwool slabs or bitumen-impregnated sarking board.

Battening

NAIL SIZES

Slate Grade Nominal thickness	Nail Length x 3.35mm dia. Minimum 10mm nailhead
<7mm	30mm minimum
>7mm	40mm minimum

Nails used throughout any roof structure should comply with the standard set out in BS 1202 : parts 2 & 3

Nail lengths should be calculated in accordance with BS 5534

MINIMUM BATTEN SIZES

450mm Rafter Centres	600mm Rafter Centres
50mm wide x 25mm deep	50mm wide x 25mm deep
50mm wide x 25mm deep	50mm wide x 25mm deep

MINIMUM RECOMMENDED LEAD CODES

Application	BS 5534 Code	LSA Code
Flashings	4	4
Soakers		
Abutment	3	3
Mitred hip	3	3
Mitred valley	3	3
Aprons		
Chimney	n/a	4
Roof head	n/a	4
Gutters		
Chimney	n/a	5
Linings	n/a	5
Ridge rolls	n/a	4
Hip rolls	n/a	4 (or 5)
Valley linings	5	4 (or 5)
Saddles	4	n/a

RECOMMENDED HEADLAPS FOR UNDERLAYS

Pitch	Minimum Headlap	
	Fully Supported	Not Supported
20°-34°	100mm	150mm
+ 35°	75mm	100mm



LEAD STAINING

Lead develops a patina of lead carbonate which can be washed off by rain and can cause staining of slates. It is strongly recommended that all lead which may discharge water onto slate, including soakers, should be treated with patination oil as it is fixed.

For more information contact the

Lead Sheet Association,

Unit 10 Archers Park

Brainbridges Road

East Peckham

Kent

TN12 5HP

Tel: 01622 872432

Fax: 01622 871649

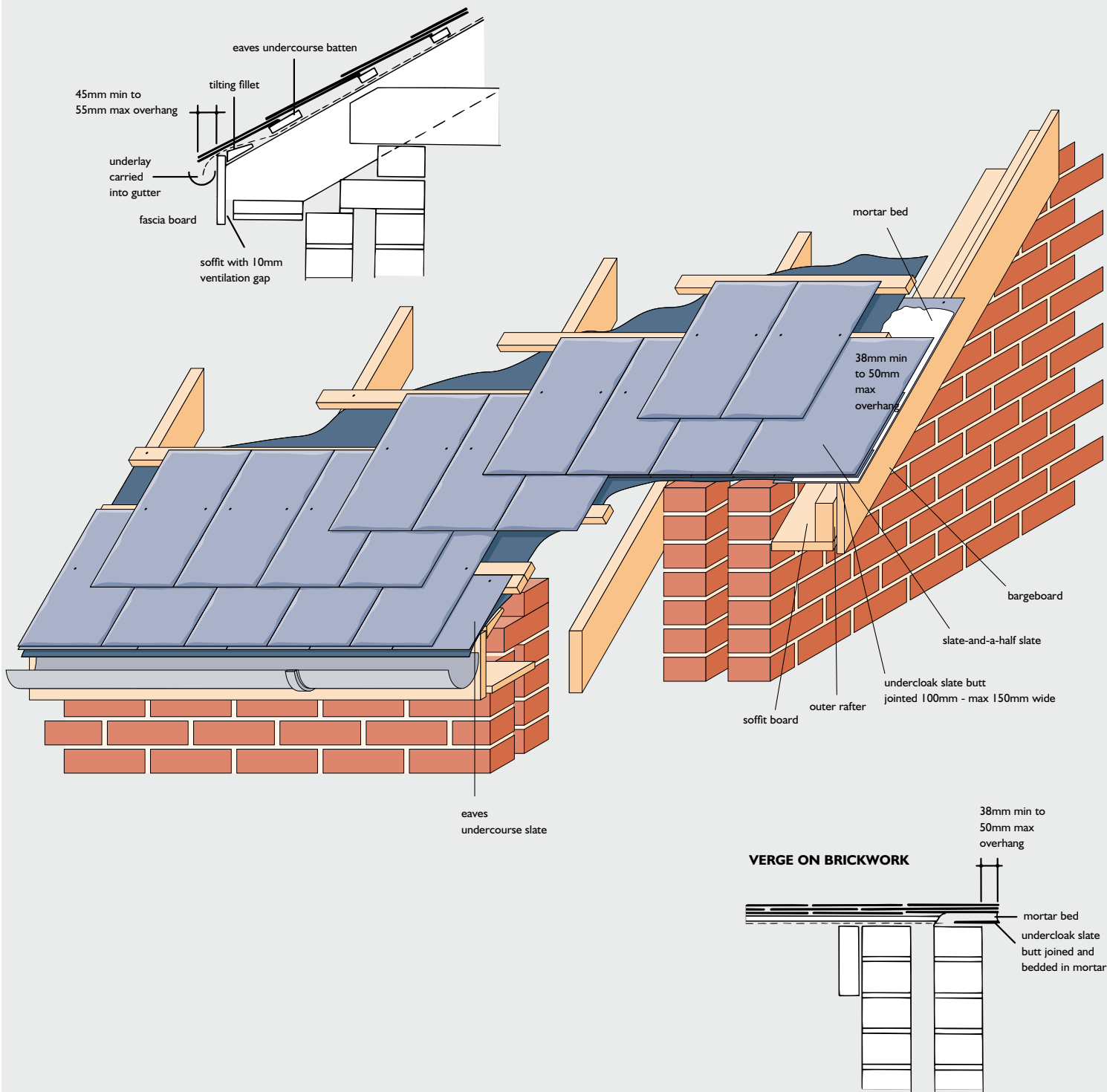

Eaves and Verges

19

EAVES

Dress underlay into gutter and pull tight to ensure no water retaining troughs and support with tilting fillet. Fix undereaves and eaves course of slates with tails aligned and projecting 45mm (minimum) to 55mm (maximum) beyond the fascia tilting fillet or wall face.

Longer slate nails may be required at the eaves courses.

VERGE ON BARGEBOARD

Ensure that undercloak and underlay are well lapped. Nail undercloak fair face down, to a true line and projecting 38mm (minimum) to 50mm (maximum) from face of bargeboard. Fill the gap between undercloak and slates with mortar, and strike off to give a neat, flush joint. Mortar for bedding and pointing, 1:3 cement:sand pigmented to match colour of slates.

VERGE ON BRICKWORK

Ensure that undercloak and underlay are well lapped. Bed undercloak in mortar fair face down, to a true line, projecting 38mm (minimum) to 50mm (maximum) beyond face of wall, and point neatly to match in with joints in walling. Cut verge slates as necessary and fix flush with undercloak. Fill the gap between undercloak and slates with mortar, and strike off to give a neat, flush joint. Mortar for bedding and pointing, 1:3 cement:sand pigmented to match colour of slates. Note: Where possible use slate-and-a-half slates to alternate courses to form verges.

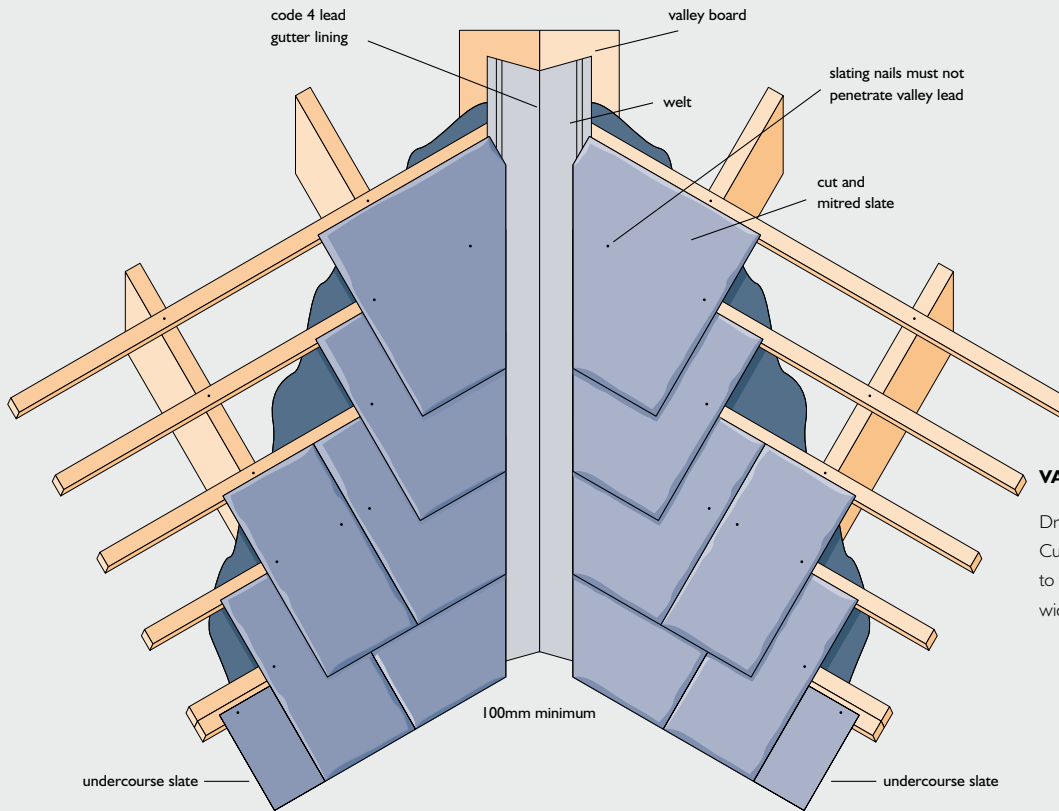

VALLEY GUTTER

Dress underlay over tilting fillets. Cut slates neatly and accurately to form a gap not less than 100mm wide centred on the gutter.

Minimum recommended open lead valleys (mm)

Roof pitch°	Area m ² (on plan)	Rain fall rate mm/hr		
		75	150	225
20-22	<25	100	125	125
	25-100	125	150	200
22.5-29	<25	100	100	100
	25-100	100	125	150
30-34	<25	100	100	100
	25-100	100	100	125
35+	<25	100	100	100
	25-100	100	100	100

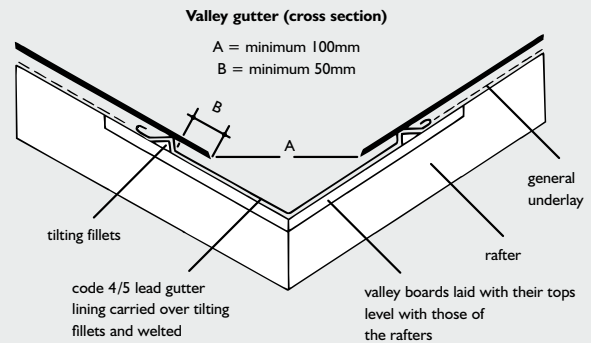

Rafter length maximum = 5m for areas of up to 25m²
 Rafter length >5m and <10m for areas of up to 25-100m²
 No vertical projections drain on to roof.

For further information please contact [Welsh//Slate Technical Department](#).

Valleys

MITRED VALLEY

Cover with a strip of underlay 600mm wide, underlapping general underlay. Cut slates neatly and accurately and interleave with lead soakers to form a straight, close, weathertight mitred junction. Fix soakers by nailing to battens at the top edge. Minimum recommended pitch is 50°, for pitches below this please contact [Welsh//Slate Technical Department](#).

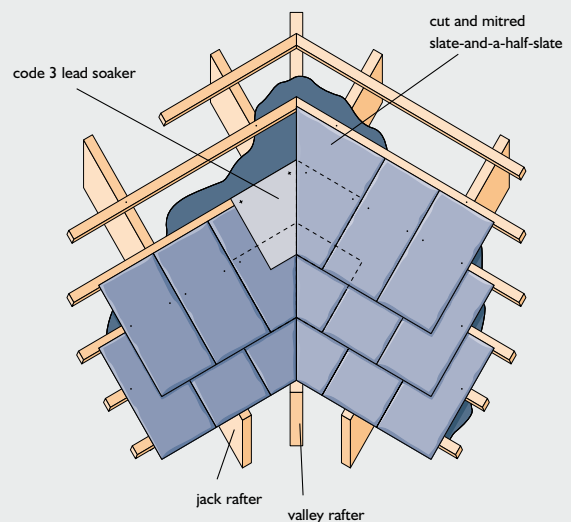

MITRED HIP

Cover with a strip of underlay 600mm wide, overlapping general underlay. Cut slates neatly and accurately, bevelled edge down. Interleave with lead soakers to form a straight, weathertight, close-mitred junction. Fix soakers by nailing to battens at the top edge.

N.B. Careful consideration must be given to mitred hip details at low roof pitches and in areas of severe exposure - contact Welsh//Slate Technical Department

Mitred hips are not generally recommended below 30° pitches.

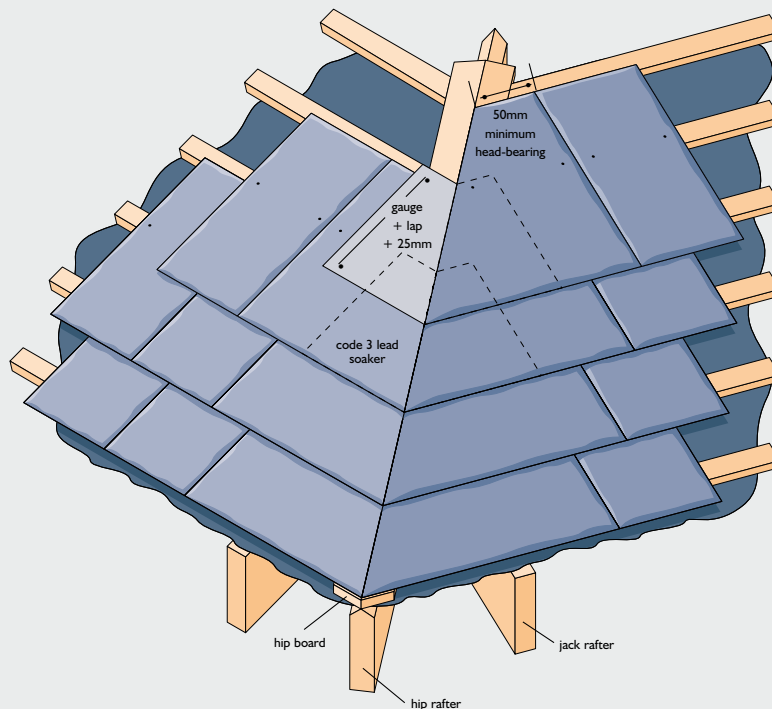

MITRED HIP SOAKER WIDTHS.

Pitch	Minimum Width at head
30°-35°	150mm
35° +	100mm

Hips

TILED HIP

Cover with a strip of underlay 600mm wide, overlapping general underlay. Fix hip iron to hip rafter with 5mm hot dipped galvanised screws or nails.

Hip irons to BS 5534: 2003, hot-dip galvanised after manufacture. Cut slates to fit closely at junction. Make weathertight with ridge tiles laid to a true line with edges and joints, solidly bedded in mortar, neatly struck off flush as the work proceeds. Shape first tile to align with corner of eaves and fill end with mortar and slips of slate finished flush. Mortar for bedding hip tiles 1:3 cement:sand pigmented to approved colour.

TILED HIP

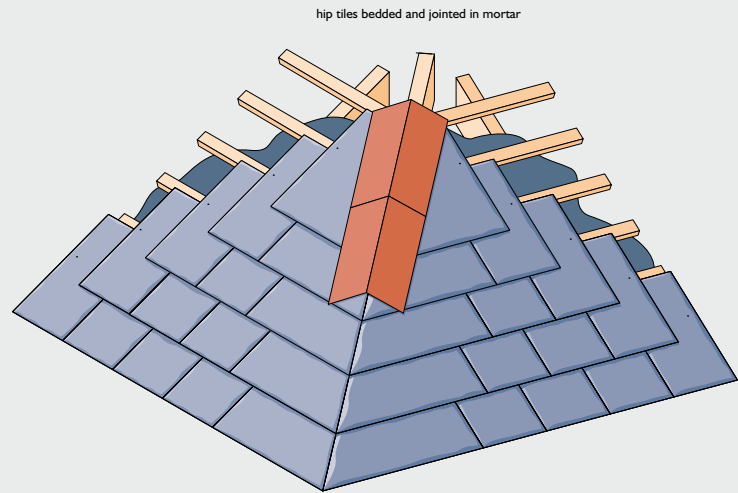

METAL ROLL HIPS

Metal roll hips should conform with sheet metal technical recommendations.

For advice on pitches less than 30°, contact the Welsh//Slate Technical Department.

HIP WITH LEAD ROLL

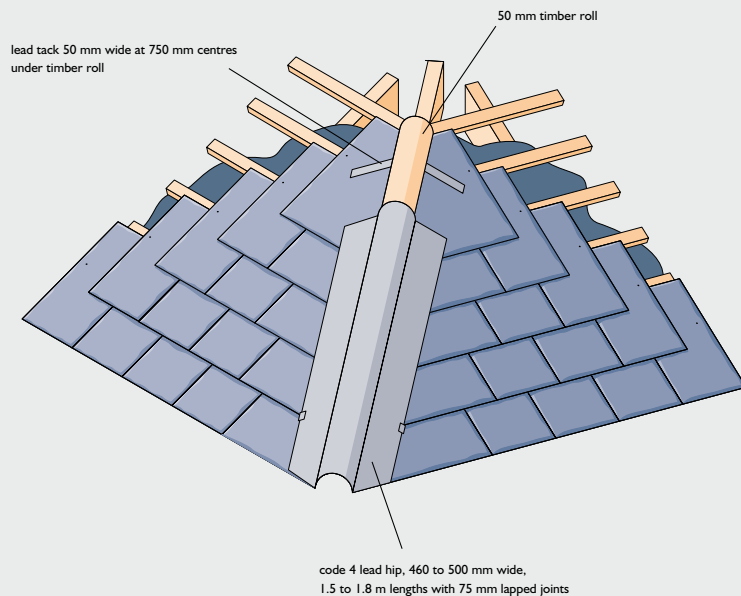

RIDGE TILE

Welsh//Slate ridge tiles are made from Penrhyn Heather Blue natural slate, at our Penrhyn quarry in North Wales.

Available in three angles
90°
105°
115°

Dimensions
Length: 450mm
Wing length: 150mm
Thickness: 15mm

Manufacturing tolerances:
Length and Width +/- 2mm
Thickness +/- 3mm

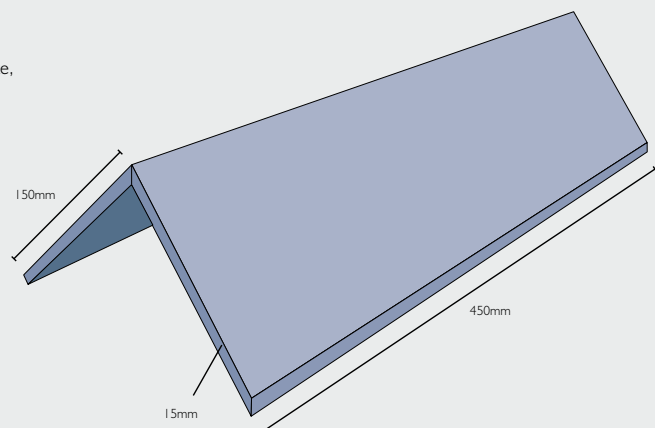

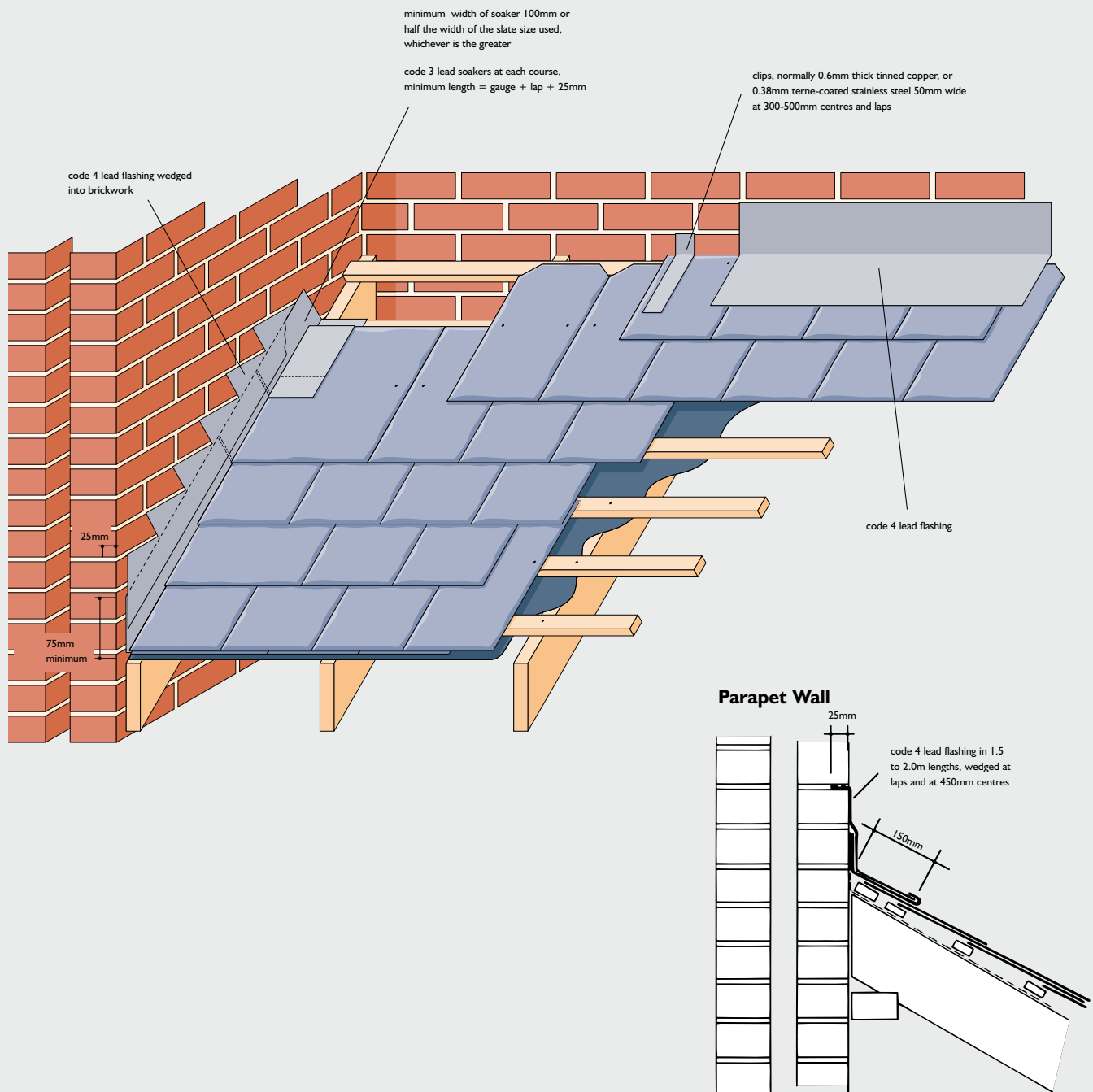

Abutments

SLOPING EDGE

Cut slates as necessary and interleave with lead soakers to form a close, weathertight abutment. Fix soakers by turning down over the head of each slate. Ensure that lead flashings are neatly dressed down over soakers immediately after slating is complete.

TOP COURSE

Turn underlay 100mm up abutment. Finish slating with a head-nailed short course to maintain gauge. Ensure that flashings are fixed immediately after slating is complete.

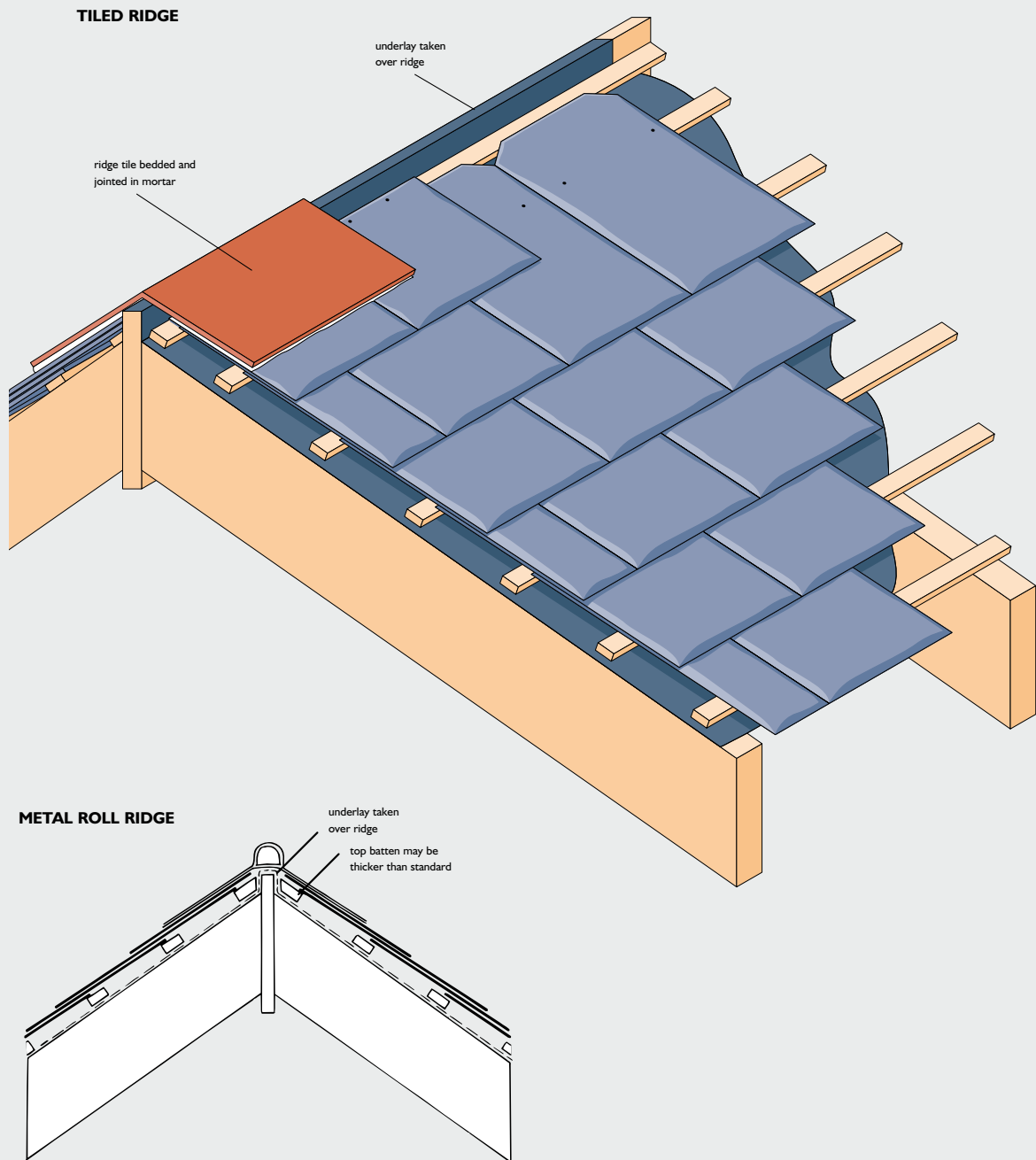

Ridges

TILED RIDGE

Lay a length of underlay over ridge to overlap general underlay by not less than 150mm. Finish slating with a head-nailed short course to maintain gauge. Make weathertight with ridge tiles laid to a true line with edges and joints solidly bedded in mortar; neatly struck off flush as the work proceeds. Fill ends of ridges at gables with mortar and slips of slate finished flush. Mortar for bedding ridge tiles, 1:3 cement:sand pigmented to approved colour.

Where it is necessary to adjust gauges to ensure adequate ridge covering overlap, the last two courses may be cut providing that the minimum headlap is maintained.

METAL ROLL RIDGE

Code 4 or 5 lead ridge, 460 to 500mm wide, 1.5 to 1.8 metre lengths with welted joints. Lead tack 50mm wide at 150mm centres, under timber roll. Horizontal laps at 150mm.

MANSARD ROOF

CHANGE IN PITCH: GREATER THAN 150°

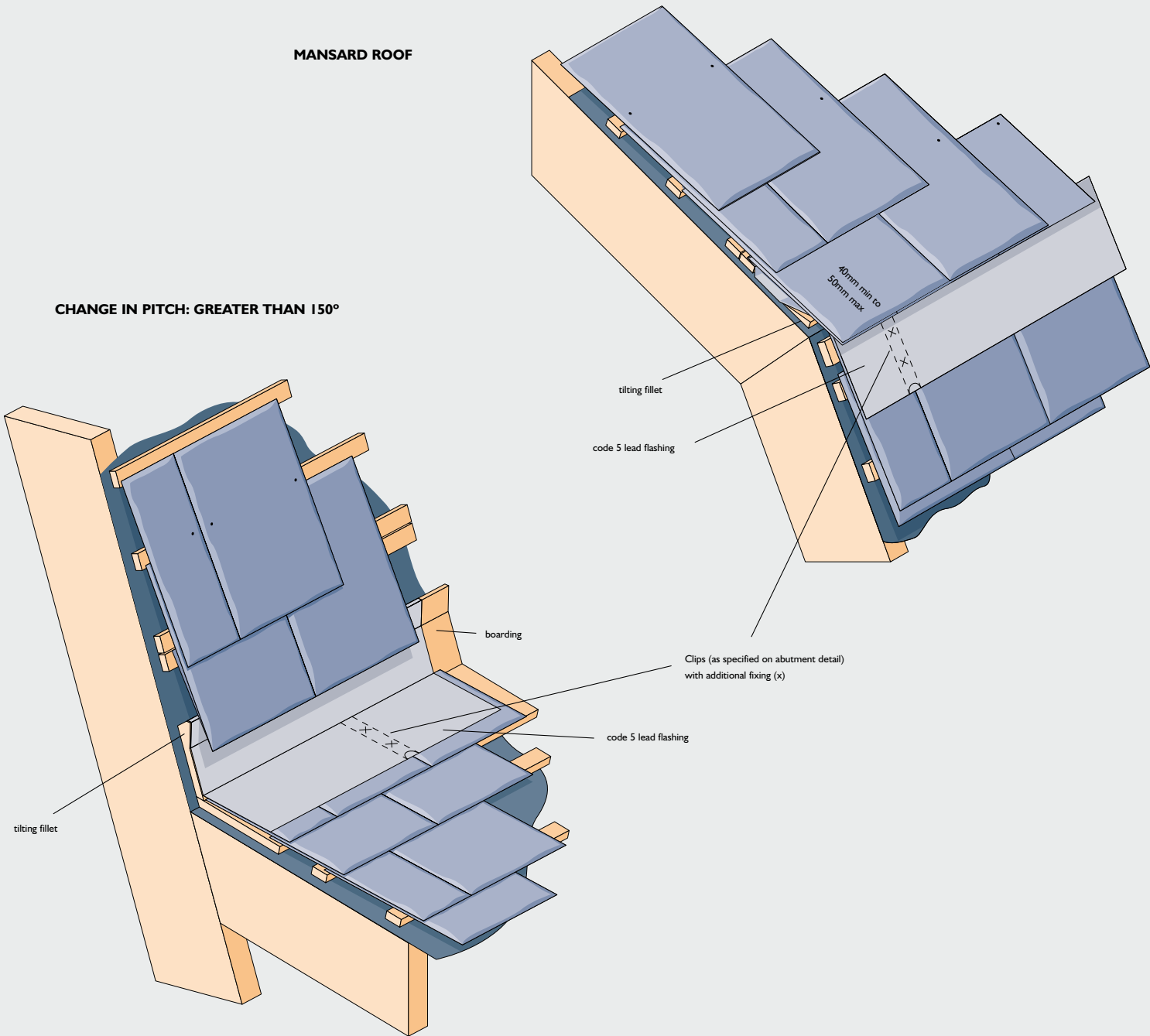

Changes in Roof Pitch

VERTICAL SLATING

Fix Welsh **Slate** roofing in accordance with BS 5534: 2003.

BOTTOM EDGES

Fix additional batten for under eaves course. Fix slates with tails neatly aligned. A tilting fillet should be used to support the eaves course.

TOP EDGES

Finished with head-nailed short course to maintain gauge.

ABUTMENTS

Cut slates as necessary to leave a neat 5mm gap adjacent to abutment, or use purpose-made slate-and-a-half.

ANGLES

Cut slates as necessary and interleave with lead soakers to form a neat, weathertight, close mitred junction. Fix soakers by nailing to battens at the top edge.

ROOF VERGES

Splay cut slates at ends of courses to fit closely under verge.

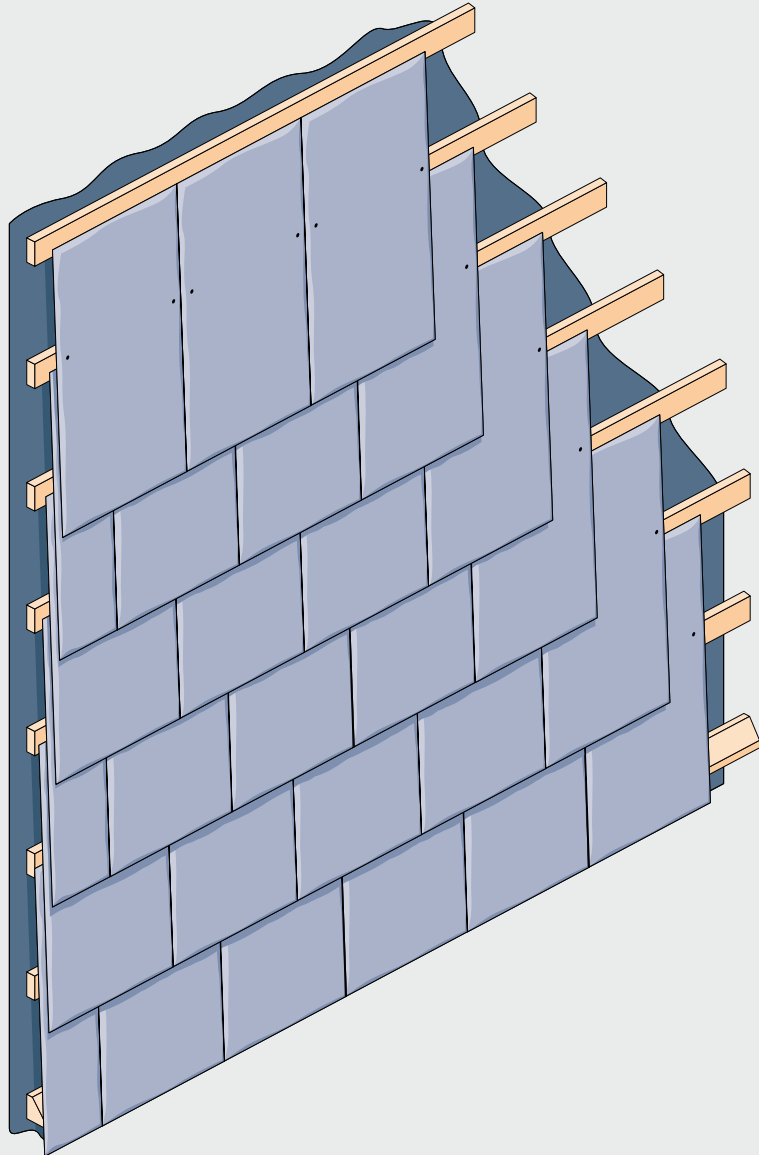

Vertical Slating

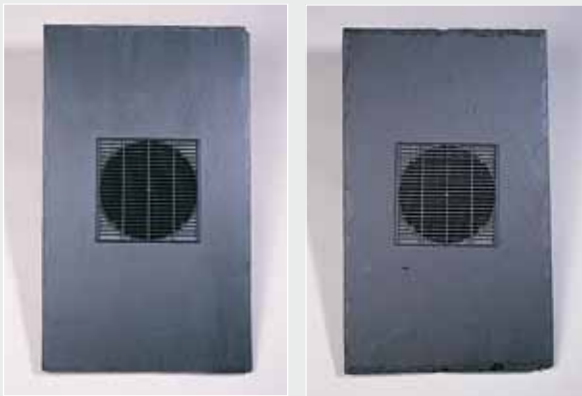

Roofing Ventilation

27

Building Regulation Approved Document F2 (England and Wales), Building Standards (Scotland) G4.1 and Building Regulation (Northern Ireland) C8 require that adequate provision is made in all roof voids to prevent excessive condensation.

Further guidance is also given in BS 5250: 2002 Code of Practice for the Control of Condensation in Buildings.

The most effective means of controlling harmful condensation is to provide efficient roofspace ventilation.

This can be achieved by providing eaves/low level through to ridge/high level ventilation.

Welsh//Slate Ventilators have been purpose designed to provide efficient roof ventilation terminals.

These combine the natural slate from our comprehensive range of slates and a discreet integral roof ventilation unit and underlay protector.

The Welsh//Slate Ventilators can be used as roof terminals for natural ventilation and with adaptors as mechanical ventilation and soil pipe ventilation terminals.

For further information please contact the Welsh//Slate Technical Department.

INSTALLATIONS

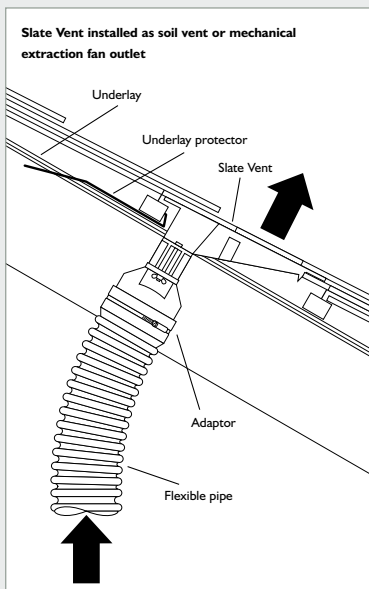
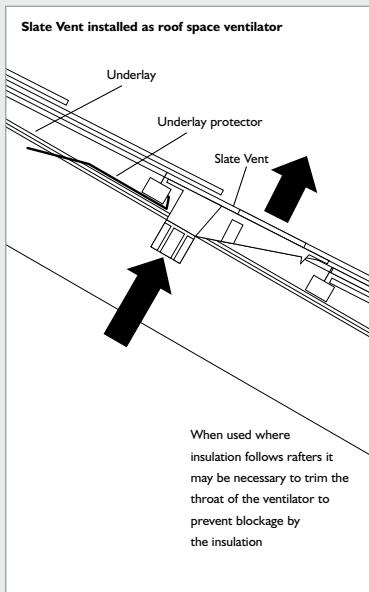

AIRFLOW CHARACTERISTICS

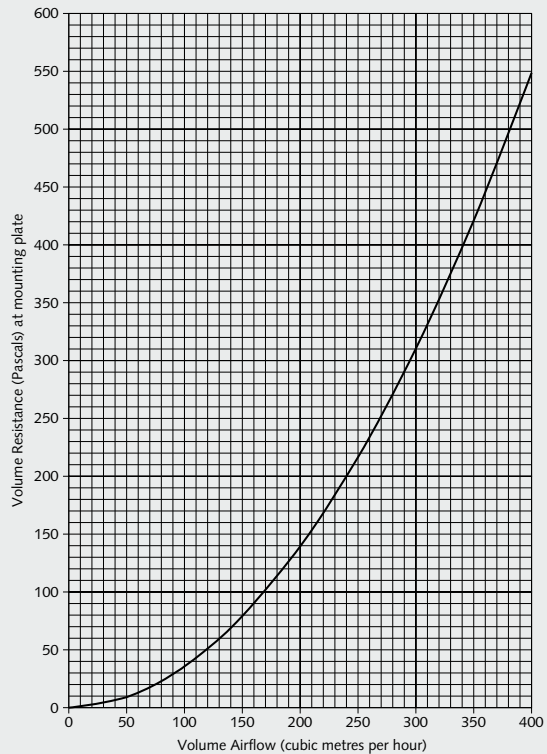

PERFORMANCE:

Nett free ventilation area:	10,000mm ²
Minimum pitch:	22.5°
Spacing centres to achieve ventilation area of:	
5,000mm ² /metre	2.0m
10,000mm ² /metre	1.0m
Airflow resistance with pipe adaptor at:	
54m ³ /hour (15 litres/sec)	9.6Pa
108m ³ /hour (30 litres/sec)	38.0Pa
216m ³ /hour (60 litres/sec)	149.7Pa

Natural Slate Ventilators

BENEFITS

- Suitable for mechanical, soil pipe and natural ventilation
- Enhanced sidelap feature to accommodate angle of creep requirements
- Driving rain resistant - tested to meet worst UK conditions
- External SAA fire rating
- 4mm large insect grille
- Roof underlay protector included to maintain integrity of underlay
- Injection moulded lower tray and grille
- Designed to BS EN ISO 9001 and 9002 independent accreditation

REFERENCES

Building Regulation Approved Document F2: 1995 edition 'Condensation in Roofs'
 Building Regulation Approved Document H1: 1992 edition 'Sanitary Pipework and Drainage'
 BS 5250: 2002 'Code of Practice for Control of Condensation in Buildings'
 BS 5534: 2003 'Code of Practice for Slating and Tiling',
 British Standards (Scotland) Regulations 1990-1994, Technical Standards for Compliance G4.1
 'Interstitial Condensation' British Regulations (Northern Ireland) 1994, C8

SPECIFICATION CLAUSES:

Roofspace Ventilation

Provide low/high level roofspace ventilation by means of a Welsh//Slate Ventilator, ensure correct installation of underlay protector. Install at 2m or 1m centres to provide ventilation equivalent to 5,000/10,000mm²/metre in accordance with Building Regulations Approved Document F2: 1995 and BS 5250: 2002. Fix in accordance with manufacturers instructions.

SOIL VENT PIPE AND MECHANICAL EXTRACTION TERMINALS

Soil vent pipe stacks/mechanical extraction ducting to be terminated at the roofslope by means of Welsh//Slate Ventilator, ensure correct installation of underlay protector. Attach Welsh//Slate Vent Pipe Adaptor and Flexible Pipe, ensure all joints and connections are airtight in accordance with Building Regulations Approved Document H1: 1990. Fix in accordance with manufacturers instructions. All pipes and ducts in cold roofspaces are to be insulated.

Manufacturing Process

Welsh//Slate roofing is crafted using a combination of traditional skills and techniques developed over centuries, combined with modern production processes to ensure all our roofing slates are of the highest standard.

Slate blocks from the quarry which have certain characteristics that will allow them to make the finest roofing slates; are identified within the quarry, extracted and transported to the manufacturing plant.

The slate blocks are cut to size using laser guided saws. The slate blocks are then split to their final thickness using traditional skills and tools, before being dressed to size with chamfered edges.



RIBA Approved Seminars

29

Welsh//Slate provide architects and designers free CPD seminars on slate roofing, cladding and flooring.

If you would like to find out more please contact +44 (0) 1248 604 206.





FM 539236



EMS 539237



BS EN 12326-1:2004
KM 8014

Quality Assurance

QUALITY ASSURANCE

Welsh//Slate were the first natural slate manufacturer in the world to achieve ISO9002 accreditation to produce roofing slates satisfying BS680.

The company exercises stringent quality control measures at all stages of extraction and manufacture through to delivery.

Welsh//Slate roofing is produced in accordance with BS EN 12326 - 1:2004 and surpass its requirements for use in all conditions.

Today, Welsh//Slate roofing is produced in accordance with ISO9001:2008 Quality Management System FM53926.

ENVIRONMENTAL RESPONSIBILITY

Welsh//Slate is committed to conducting our business in an environmentally responsible manner. We have a responsibility to maximise the environmental benefits, to minimise the environmental impact and to promote sustainable development within our operations and the services we provide.

Welsh//Slate operates an Environmental Management System, EMS 53927, certificated to ISO 1400:2004 EMS 53927.

Welsh//Slate is committed to restoring and remodelling landscapes that are affected by quarrying. With this aim we operate a joint venture, The Slate Ecology Company, with Cynefin Environmental Consultants. Exceptionally high environmental performance standards have been achieved through development programmes that use natural materials and processes to recreate the unique character of each site.

Welsh//Slate Customers Services

Welsh Slate offers the following free services

Sample Service

Tel: +44 (0) 1248 603217
email: enquiries@welshslate.com

RIBA Approved CPD Presentations

Tel: +44 (0) 1248 604206
email: enquiries@welshslate.com

For all other enquiries please contact

Tel: +44 (0) 1248 600656
email: enquiries@welshslate.com



ROOFING
FLOORING
PAVING
CLADDING
WORKTOPS
LANDSCAPING

Welsh Slate Limited
Penrhyn Quarry,
Bethesda,
Bangor,
Gwynedd.
LL57 4YG
United Kingdom

Telephone: +44 (0) 1248 600 656
Fax: +44 (0) 1248 601 171
Website: www.welshslate.com
e-mail: enquiries@welshslate.com

Due to the limitations of reproduction and printing, the colours of the slate shown in this brochure are representative only.

Welsh//Slate